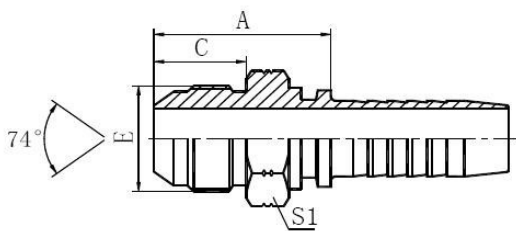

INDEX

P/N	PAGE
16711(JIC MALE 74° CONE).....	2
26711(JIC FEMALE 74° CONE SEAT).....	3
26711D(JIC FEMALE 74° CONE SEAT DOUBLE HEXAGON).....	4
26711D-SM(JIC FEMALE 74° CONE SEAT DOUBLE HEXAGON).....	5
26741(45° JIC FEMALE 74° CONE SEAT).....	6
26791(90° JIC FEMALE 74° CONE SEAT).....	7
14211(ORFS MALE O-RING SEAL).....	8
24211(ORFS FEMALE FLAT SEAT).....	9
24241(45° ORFS FEMALE FLAT SEAT).....	10
24291(90° ORFS FEMALE FLAT SEAT).....	11
15611(NPT MALE).....	12
16011(SAE O-RING MALE).....	13
17811(SAE MALE 90° CONE).....	14
27811(SAE FEMALE 90° CONE SEAT).....	14
27841(45° SAE FEMALE 90° CONE SEAT).....	15
27891(90° SAE FEMALE 90° CONE SEAT).....	16
21611(NPSM FEMALE 60° CONE).....	17
21641(45° NPSM FEMALE 60° CONE).....	18
21691(90° NPSM FEMALE 60° CONE).....	19

16711

美制 JIC 外螺纹 74°外锥面

JIC MALE 74°CONE ISO 8434-2—SAE J514



代号 P/N	螺纹 E THREAD	软管 HOSE BORE		尺寸 DIMENSIONS		
		公称内径 DN	标号 DASH	A	C	S1
16711-04-04	7/16"×20	6	04	26.5	14	12
16711-05-04	1/2"×20	6	04	26.5	14	14
16711-05-05	1/2"×20	8	05	26.5	14	14
16711-06-04	9/16"×18	6	04	26.5	14.1	17
16711-06-05	9/16"×18	8	05	26.5	14.1	17
16711-06-06	9/16"×18	10	06	26.5	14.1	17
16711-08-06	3/4"×16	10	06	31.5	16.7	22
16711-08-08	3/4"×16	12	08	32	16.7	22
16711-10-08	7/8"×14	12	08	34.3	19.3	24
16711-10-10	7/8"×14	16	10	35.5	19.3	24
16711-12-08	1.1/16×12	12	08	39	21.9	27
16711-12-10	1.1/16×12	16	10	40	21.9	27
16711-12-12	1.1/16×12	20	12	40	21.9	27
16711-12-16	1.1/16×12	25	16	41	21.9	30
16711-14-10	1.3/16×12	16	10	41.5	22.6	32
16711-14-12	1.3/16×12	20	12	40.6	22.6	32
16711-16-12	1.5/16×12	20	12	42.5	23.1	36
16711-16-16	1.5/16×12	25	16	43.5	23.1	36
16711-20-16	1.5/8×12	25	16	46.5	24.3	46
16711-20-20	1.5/8×12	32	20	47.5	24.3	46
16711-24-20	1.7/8×12	32	20	53	27.5	50
16711-24-24	1.7/8×12	40	24	53	27.5	50

16711-31-32	2.1/2×12	50	32	62	33.9	65
<p>Note: 1. For use with braided hoses.</p> <p>2. If use with spiral hose, hose fitting series number is 16712-xx-xx</p>						

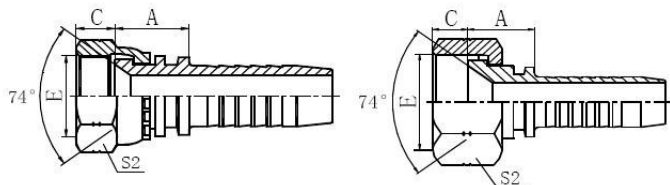

26711

26711-T

美制 JIC

内螺纹 74°外锥面

JIC FEMALE 74° CONE SEAT

SAE J514

代号 P/N	螺纹 E THREAD	软管 HOSE BORE		尺寸 DIMENSIONS		
		公称内径 DN	标号 DASH	A	C	S2
26711-04-04	7/16"×20	6	04	15	9	15
26711-05-05	1/2"×20	8	05	15.5	9.5	17
26711-06-04	9/16"×18	6	04	15.5	10.5	19
26711-06-06	9/16"×18	10	06	15.5	10.5	19
26711-08-06	3/4"×16	10	06	17.5	11	24
26711-08-08	3/4"×16	12	08	18	11	24
26711-10-08	7/8"×14	12	08	18.5	13	27
26711-10-10	7/8"×14	16	10	20	13	27
26711-12-08T	1.1/16"×12	12	08	19	15	32
26711-12-10	1.1/16"×12	16	10	21.5	15	32
26711-12-12	1.1/16"×12	20	12	21.5	15	32
26711-14-12	1.3/16"×12	20	12	21.5	15	36
26711-16-12T	1.5/16"×12	20	12	18.5	16	41
26711-16-16	1.5/16"×12	25	16	23	16	41
26711-16-20	1.5/16"×12	32	20	24	16	41
26711-20-16T	1.5/8"×12	25	16	23	17	50
26711-20-20	1.5/8"×12	32	20	26	17	50
26711-24-20	1.7/8"×12	32	20	26.5	20	55

26711-24-24	1.7/8"×12	40	24	26.5	20	55
26711-32-24T	2.1/2"×12	40	24	27	23.5	75
26711-32-32T	2.1/2"×12	50	32	27	23.5	75

Note: 1. For use with braided hoses.
 2. If use with spiral hose, hose fitting series number is 16712-xx-xx

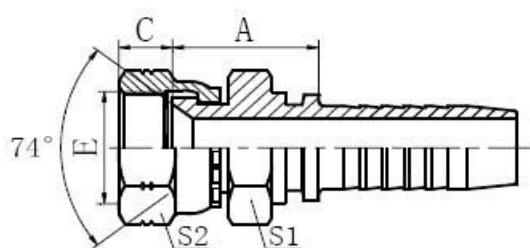

26711D

美制 JIC 内螺纹 74° 内锥面双六角

JIC FEMALE 74_ CONE SEAT DOUBLE
 HEXAGON

代号 P/N	螺纹 E THREAD	软管 HOSE BORE		尺寸 DIMENSIONS			
		公称内径 DN	标号 DASH	A	C	S1	S2
26711D-04-04	7/16"X20	6	04	20	9	15	15
26711D-05-04	1/2"X20	6	04	20.5	9.5	17	17
26711D-06-04	9/16"X18	6	04	21	10.5	19	19
26711D-06-06	9/16"X18	10	06	21	10.5	19	19
26711D-08-06	3/4"X16	10	06	25	11	24	24
26711D-08-08	3/4"X16	12	08	24.5	11	24	24
26711D-08-10	3/4"X16	16	10	25.5	11	24	24
26711D-10-08	7/8"X14	12	08	28	13	27	27
26711D-10-10	7/8"X14	16	10	29	13	27	27
26711D-12-12	1.1/16"X12	20	12	31.5	15	32	32
26711D-16-12	1.5/16"X12	20	12	33.5	16	41	41
26711D-16-16	1.5/16"X12	25	16	34.5	16	41	41
26711D-16-20	1.5/16"X12	32	20	36.5	16	41	41

26711D-20-20	1.7/16"X12	32	20	39	17	50	50
Note: 1. For use with braided hoses. 2. If use with spiral hose, hose fitting series number is 26712D-xx-xx							

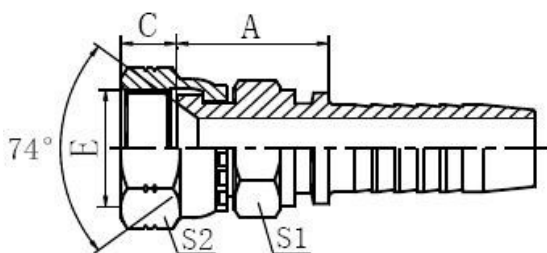

26711D-SM

美制 JIC 内螺纹 74°内锥面双六角

JIC FEMALE 74° CONE SEAT

DOUBLE HEXAGON SAE J514

代号 P/N	螺纹 E THREAD	软管 HOSE BORE		尺寸 DIMENSIONS			
		公称内径 DN	标号 DASH	A	C	S1	S2
26711D-04-04SM	7/16"X20	6	04	20	9	12	15
26711D-05-04SM	1/2"X20	6	04	20.5	9.5	12	17
26711D-06-04SM	9/16"X18	6	04	21	10.5	14	19
26711D-06-06SM	9/16"X18	10	06	21	10.5	17	19
26711D-08-06SM	3/4"X16	10	06	23	11	19	24
26711D-08-08SM	3/4"X16	12	08	24.5	11	22	24

26711D-08-10SM	3/4"X16	16	10	25.5	11	22	24
26711D-10-08SM	7/8"X14	12	08	24	13	22	27
26711D-10-10SM	7/8"X14	16	10	27	13	22	27
26711D-12-12SM	1.1/16"X12	20	12	31.5	15	27	32
26711D-16-12SM	1.5/16"X12	20	12	31.5	16	32	41
26711D-16-16SM	1.5/16"X12	25	16	32.5	16	32	41
26711D-20-20SM	1.7/16"X12	32	20	37	17	41	50

Note: 1. For use with braided hoses.

2. If use with spiral hose, hose fitting series number is 26712D-x-x-xSM

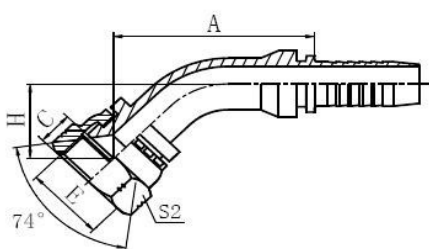

26741

45°美制 JIC 内螺纹 74° 内锥面

45° JIC FEMALE 74° CONE SEAT SAE J514

代号 P/N	螺纹 E THREAD	软管 HOSE BORE		尺寸 DIMENSIONS			
		公称内径 DN	标号 DASH	A	C	H	S2
26741-04-04	7/16"X20	6	04	40.2	9	18.1	15
26741-05-04	1/2"X20	6	04	40.5	9.5	18.5	17
26741-05-05	1/2"X20	8	05	42.7	9.5	19.3	17

26741-06-04	9/16"X18	6	04	40.5	10.5	18.5	19
26741-06-05	9/16"X18	8	05	42.7	10.5	19.3	19
26741-06-06	9/16"X18	10	06	44.3	10.5	20	19
26741-08-06	3/4"X16	10	06	45.7	11	21.4	24
26741-08-08	3/4"X16	12	08	58.6	11	23.5	24
26741-10-06	7/8"X14	10	06	46	13	21.8	27
26741-10-08	7/8"X14	12	08	58.9	13	24	27
26741-10-10	7/8"X14	16	10	70.1	13	25.3	27
26741-12-08	1.1/16"X12	12	08	60	15	25	32
26741-12-10	1.1/16"X12	16	10	71.21	15	26.4	32
26741-12-12	1.1/16"X12	20	12	77.4	15	30	32
26741-16-12	1.5/16"X12	20	12	77.4	16	30	41
26741-16-16	1.5/16"X12	25	16	85.7	16	31.5	41
26741-20-16	1.5/8"X12	25	16	86.8	17	32.5	50
26741-20-20	1.5/8"X12	32	20	97.3	17	36.6	50
26741-24-20	1.7/8"X12	32	20	97.7	20	36.9	55
26741-24-24	1.7/8"X12	40	24	112.3	20	41.6	55
26741-32-32	2.1/2"X12	50	32	131	23.5	49.5	75

Note: 1. For use with braided hoses.

2. If use with spiral hose, hose fitting series number is 26742D-xx-xx

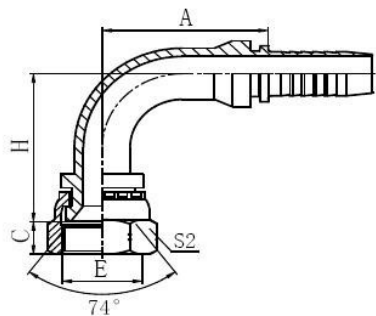

26791

90° 美制 JIC 内螺纹 74° 内锥面 90° JIC
 FEMALE 74° CONE SEAT SAE J514

代号 P/N	螺纹 E THREAD	软管 HOSE BORE		尺寸 DIMENSIONS			
		公称内径 DN	标号 DASH	A	C	H	S2
26791-04-04	7/16"X20	6	04	30	9	33.5	15
26791-05-05	1/2"X20	8	05	33	9.5	37	17
26791-06-04	9/16"X18	6	04	30	10.5	34	19
26791-06-06	9/16"X18	10	06	35.3	10.5	39.3	19
26791-08-06	3/4"X16	10	06	35.3	11	41.3	24
26791-08-08	3/4"X16	12	08	41	11	47	24
26791-10-08	7/8"X14	12	08	41	13	48	27
26791-10-10	7/8"X14	16	10	56.5	13	52.5	27
26791-12-08	1.1/16"X12	12	08	41	15	49.5	32
26791-12-10	1.1/16"X12	16	10	56.5	15	54	32
26791-12-12	1.1/16"X12	20	12	65.5	15	63.5	32
26791-14-12	1.3/16"X12	20	12	65.5	15	63.5	36
26791-16-12	1.5/16"X12	20	12	65.5	16	63.5	41
26791-16-14	1.5/16"X12	22	14	71.2	16	65.5	41

26791-16-16	1.5/16"X12	25	16	76.7	16	70	41
26791-20-16	1.5/8"X12	25	16	76.7	17	71.5	50
26791-20-20	1.5/8"X12	32	20	91.5	17	82.5	50
26791-24-20	1.7/8"X12	32	20	91.5	20	83	55
26791-24-22	1.7/8"X12	35	22	109.4	20	96.5	55
26791-24-24	1.7/8"X12	40	24	109.4	20	97.5	55
26791-32-32	2.1/2"X12	50	32	130.3	23.5	118.8	75

Note: 1. For use with braided hoses.

2. If use with spiral hose, hose fitting series number is 26792D-xx-xx

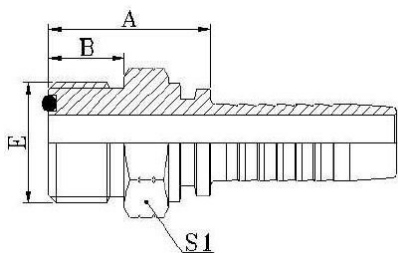

14211

美制 ORFS 外螺纹平面 O 形圈密封

ORFS MALE O-RING SEAL ISO 8434-3-SAE J1453

代号 P/N	螺纹 E THREAD	软管 HOSE BORE		O 形圈 O-RING	尺寸 DIMENSIONS		
		公称内径 DN	标号 DASH		A	C	S1
14211-04-04	9/16" X18	6	04	O011	22.3	9.8	17
14211-06-04	11/16" X16	6	04	O012	24	11.2	19
14211-06-06	11/16" X16	10	06	O012	24	11.2	19
14211-08-06	13/16" X16	10	06	O014	27.5	12.8	22
14211-08-08	13/16" X16	12	08	O014	28.5	12.8	22
14211-08-10	13/16" X16	16	10	O014	28.5	12.8	22

14211-10-08	1" X14	12	08	O016	32.5	15.5	27
14211-10-10	1" X14	16	10	O016	34	15.5	27
14211-12-08	1.3/16" X12	12	08	O018	35.5	17	32
14211-12-10	1.3/16" X12	16	10	O018	36.5	17	32
14211-12-12	1.3/16" X12	20	12	O018	36.5	17	32
14211-16-12	1.7/16" X12	20	12	O021	37	17.5	38
14211-16-16	1.7/16" X12	25	16	O021	38.5	17.5	38
14211-20-20	1.11/16" X12	32	20	O025	41.5	17.5	46
14211-24-24	2" X12	40	24	O029	43.5	17.5	55

Note: 1. For use with braided hoses.

2. If use with spiral hose, hose fitting series number is 14212-xx-xx

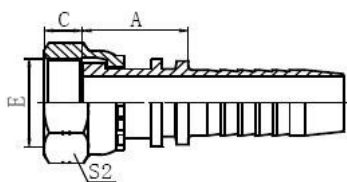

24211

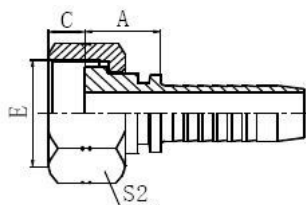

24211T

美制 ORFS 内螺纹平面密封
ORFS FEMALE FLAT SEAT ISO
12151-1—SAE J516

代号 P/N	螺纹 E THREAD	软管 HOSE BORE		O 形圈	尺寸 DIMENSIONS		
		公称内径 DN	标号 DASH	O-RING	A	C	S2
24211-04-04	9/16"X18	6	04		22.5	8.5	19
24211-06-04	11/16"X16	6	04		23.5	10	22
24211-06-06	11/16"X16	10	06		25.5	10	22
24211-08-06	13/16"X16	10	06		25	11	27
24211-08-08	13/16"X16	12	08		28	11	27
24211-10-08	1"X14	12	08		29.5	13	30
24211-10-10	1"X14	16	10		33.5	13.5	30
24211-12-06	1.3/16"X12	10	06		30	15	36
24211-12-08	1.3/16"X12	12	08		30.5	15	36
24211-12-12	1.3/16"X12	20	12		35	15	36
24211-16-12	1.7/16"X12	20	12		35	14.8	41
24211-16-14	1.7/16"X12	22	14		34	14.8	41
24211-16-16	1.7/16"X12	25	16		35	14.8	41
24211-20-20	1.11/16"X12	32	20		39.5	15	50
24211-24-24	2"X12	40	24		36	14.8	60

Note: 1. For use with braided hoses.

2. If use with spiral hose, hose fitting series number is 24212-xx-xx

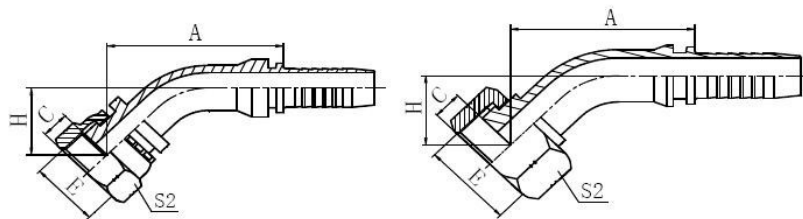

45° 45° ORFS 内螺纹平面
密封 45° ORFS FEMALE FLAT
SEAT ISO 12151-1—SAE
J516

24241

24241-T

代号 P/N	螺纹 E THREAD	软管 HOSE BORE		尺寸 DIMENSIONS			
		公称内径 DN	标号 DASH	A	C	H	S2
24241-04-04	9/16"X18	6	04	45.5	8.5	23.4	19
24241-06-06	11/16"X16	10	06	51.7	10	27.4	22
24241-08-06T	13/16"X16	10	06	44.6	11	20.3	27
24241-08-08	13/16"X16	12	08	65.3	11	30.4	27
24241-10-10	1"X14	16	10	79.7	13.5	34.9	30
24241-12-12	1.3/16"X12	20	12	87.6	15	39.5	36
24241-16-14T	1.7/16"X12	22	14	78.7	14.8	28.5	41
24241-16-16T	1.7/16"X12	25	16	84.1	14.8	29.7	41
24241-20-18T	1.11/16"X12	28	18	91	15	33.8	50
24241-20-20	1.11/16"X12	32	20	106.9	15	46.1	50
24241-24-24T	2"X12	40	24	108.5	14.8	37.7	60

Note: 1. For use with braided hoses.
2. If use with spiral hose, hose fitting series number is 24242-xx-xx

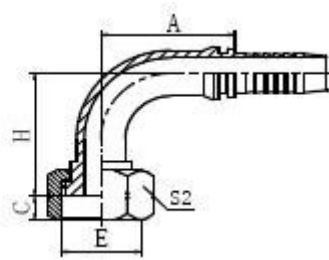
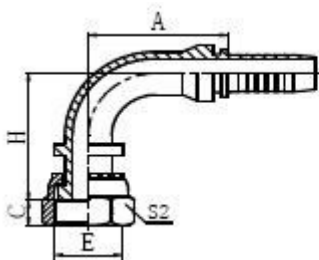

90° ORFS 内螺纹平面密封

90° ORFS FEMALE FLAT SEAT ISO
12151-1—SAE J516

24291

24291T

代号 P/N	螺纹 E THREAD	软管 HOSE BORE		尺寸 DIMENSIONS			
		公称内径 DN	标号 DASH	A	C	H	S2
24291-04-04	9/16"X18	6	04	30	8.5	41	19
24291-06-06	11/16"X16	10	06	35.3	10	49.8	22
24291-08-08	13/16"X16	12	08	41	11	57	27
24291-10-08T	1"X14	12	08	41	13	46	30
24291-10-10	1"X14	16	10	56.5	13.5	66	30
24291-12-12	1.3/16"X12	20	12	66.2	15	77	36
24291-16-14T	1.7/16"X12	22	14	71.2	14.8	63	41
24291-16-16T	1.7/16"X12	25	16	76.9	14.8	67.5	41
24291-20-16T	1.11/16"X12	25	16	76.7	15	67.5	50
24291-20-18T	1.11/16"X12	28	18	87.9	15	78.5	50
24291-20-20	1.11/16"X	32	20	91.5	15	96	50
24291-24-24T	2"X12	40	24	109.4	14.8	92	60

Note: 1. For use with braided hoses.
 2. If use with spiral hose, hose fitting series number is 24292-xx-xx

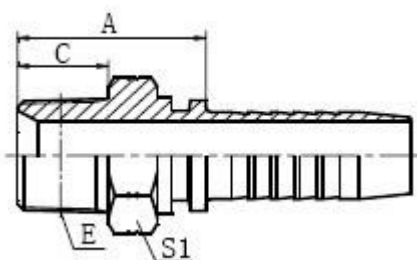

15611

布锥管外螺纹 NPT MALE

代号 P/N	螺纹 E THREAD	软管 HOSE BORE		尺寸 DIMENSIONS		
		公称内径 DN	标号 DASH	A	C	S1
15611-04-04	Z1/4"X18	6	04	28	14	17
15611-04-06	Z1/4"X18	10	06	27	14	17
15611-06-04	Z3/8"X18	6	04	28	15	19
15611-06-05	Z3/8"X18	8	05	28	15	19
15611-06-06	Z3/8"X18	10	06	30	15	19
15611-08-06	Z1/2"X14	10	06	34.5	19.5	22
15611-08-08	Z1/2"X14	12	08	34.5	19	22
15611-12-08	Z3/4"X14	12	08	37.5	19.5	30
15611-12-10	Z3/4"X14	16	10	38	19.5	30
15611-12-12	Z3/4"X14	20	12	38.5	19.5	30
15611-16-10	Z1"X11.5	16	10	45	25.5	36

15611-16-12	Z1"X11.5	20	12		45	25.5	36
15611-16-16	Z1"X11.5	25	16		44.5	24	36
15611-20-16	Z1.1/4"X11.5	25	16		49.5	26.5	46
15611-20-20	Z1.1/4"X11.5	32	20		49	25	46
15611-24-24	Z1.1/2"X11.5	40	24		51	26	50
15611-32-32	Z2"X11.5	50	32		55	27	65

Note: 1. For use with braided hoses.

2. If use with spiral hose, hose fitting series number is 156 2-xx-xx

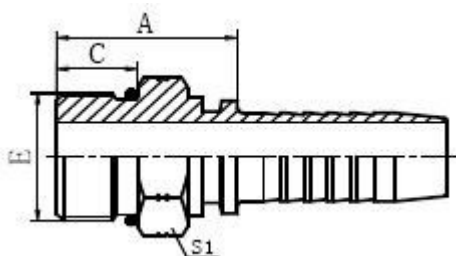

16011

美制 SAE 外螺纹带 O 形圈

SAE O-RING MALE ISO 11926—SAE J2926

代号 P/N	螺纹 E THREAD	软管 HOSE BORE		O 形圈 O-RING	尺寸 DIMENSIONS		
		公称内径 DN	标号 DASH		A	C	S1
16011-04-04	7/16"X20	6	04	8.92X1.83	21.5	9.1	14
16011-05-04	1/2"X20	6	04	10.52X1.8	21.5	9.1	17
16011-06-05	9/16"X18	8	05	11.89X1.9	22.5	9.9	17
16011-06-06	9/16"X18	10	06	11.89X1.9	22.5	9.9	17
16011-08-06	3/4"X16	10	06	16.36X2.2	24.5	11.1	22

16011-08-08	3/4"X16	12	08	16.36X2.2	25	11.1	22
16011-10-08	7/8"X14	12	08	19.18X2.4	29.5	12.7	27
16011-10-10	7/8"X14	16	10	19.18X2.4	30.5	12.7	27
16011-12-10	1.1/16"X12	16	10	23.47X2.9	34	15.09	32
16011-12-12	1.1/16"X12	20	12	23.47X2.9	34	15.1	32
16011-16-16	1.5/16"X12	25	16	29.74X2.9	36	15.1	38

Note: 1. For use with braided hoses.
 2. If use with spiral hose, hose fitting series number is 16012-xx-xx

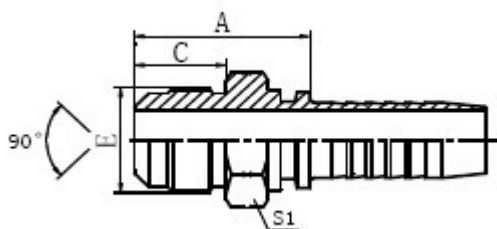

17811

美制 SAE 外螺纹 90° 外锥面

SAE MALE 90° CONE SAE J513

代号 P/N	螺纹 E THREAD	软管 HOSE BORE		尺寸 DIMENSIONS		
		公称内径 DN	标号 DASH	A	C	S1
17811-04-04	7/16"X20	6	04	25.5	12.7	12
17811-05-05	1/2"X20	8	05	27	14.2	14
17811-06-06	5/8"X18	10	06	28.5	15.7	17
17811-08-08	3/4"X16	12	08	34	19	22
17811-10-10	7/8"X14	16	10	38.5	22.4	24

17811-12-12	1.1/16"X14	20	12		43.5	25.4	30
-------------	------------	----	----	--	------	------	----

Note: 1. For use with braided hoses.
2. If use with spiral hose, hose fitting series number is 178 2-x x-x x

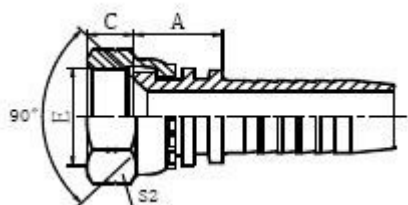

27811

美制 SAE 外螺纹 90° 内锥面

SAE FEMALE 90° CONE SEAT SAE J513

代号 P/N	螺纹 E THREAD	软管 HOSE BORE		尺寸 DIMENSIONS		
		公称内径 DN	标号 DASH	A	C	S1
27811-04-0	7/16"X20	6	04	15	9	15
27811-05-0	1/2"X20	8	05	15.5	9.5	17
27811-06-0	5/8"X18	10	06	17	11.3	22
27811-08-0	3/4"X16	12	08	18	11	24
27811-10-1	7/8"X14	16	10	20	13	27
27811-12-1	1.1/16"X14	20	12	21.5	14.3	32

Note: 1. For use with braided hoses.
2. If use with spiral hose, hose fitting series number is 278 2-x x-x x

27841

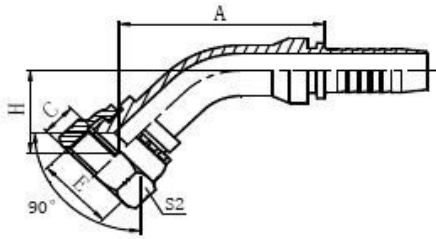

45° 美制 SAE 外螺纹 90° 内锥面 45° SAE
 FEMALE 90° CONE SEAT SAE J513

代号 P/N	螺纹 E THREAD	软管 HOSE BORE		尺寸 DIMENSIONS			
		公称内径 DN	标号 DASH	A	C	H	S2
27841-06-04	5/8"X18	6	04	42	11.3	19.9	22
27841-06-05	5/8"X18	8	05	44.1	11.3	20.7	22
27841-06-06	5/8"X18	10	06	45.7	11.3	21.4	22
27841-08-08	3/4"X16	12	08	58.2	11	23.3	24
27841-10-08	7/8"X14	12	08	58.2	13	23.3	27
27841-10-10	7/8"X14	16	10	69.4	13	24.6	27
27841-12-12	1.1/16"X14	20	12	77.4	14.3	30	32

Note: 1. For use with braided hoses.
 2. If use with spiral hose, hose fitting series number is 27842-x x -x x

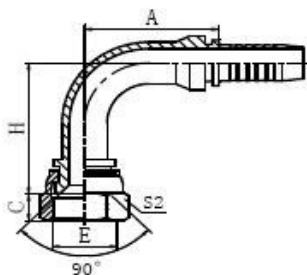

27891

90° 美制 SAE 外螺纹 90° 内锥面 90° SAE FEMALE
 90° CONE SEAT SAE J513

代号 P/N	螺纹 E THREAD	软管 HOSE BORE		尺寸 DIMENSIONS			
		公称内径 DN	标号 DASH	A	C	H	S2
27841-06-04	5/8"X18	6	04	42	11.3	19.9	22
27841-06-05	5/8"X18	8	05	44.1	11.3	20.7	22
27841-06-06	5/8"X18	10	06	45.7	11.3	21.4	22
27841-08-08	3/4"X16	12	08	58.2	11	23.3	24
27841-10-08	7/8"X14	12	08	58.2	13	23.3	27
27841-10-10	7/8"X14	16	10	69.4	13	24.6	27
27841-12-12	1.1/16"X14	20	12	77.4	14.3	30	32

Note: 1. For use with braided hoses.
 2. If use with spiral hose, hose fitting series number is 27892-xx-xx

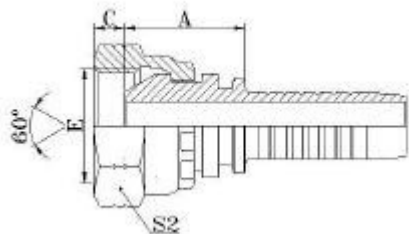

21611

NPSM FEMALE 60° CONE SAE J514

代号 P/N	螺纹 E THREAD	软管 HOSE BORE		尺寸 DIMENSIONS		
		公称内径 DN	标号 DASH	A	C	S1
21611-04-04	1/4"X18	6	04	22	4.6	19
21611-06-04	3/8"X18	6	04	23	6	22
21611-06-05	3/8"X18	8	05	23	6	22
21611-06-06	3/8"X18	10	06	23	6	22
21611-08-08	1/2"X14	12	08	23.5	7.5	27
21611-12-10	3/4"X14	16	10	27	8.9	32
21611-12-12	3/4"X14	20	12	27	8.9	32
21611-16-12	1"X11.5	20	12	25	10.5	41

21611-16-16	1"X11.5	25	16		28.5	10.5	41
21611-20-20	1.1/4"X11.5	32	20		29.5	11.2	50
21611-24-20	1.1/2"X11.5	32	20		29.5	11.2	55
21611-24-24	1.1/2"X11.5	24	31.5		31.5	11.2	55
21611-32-32	2"X11.5	50	32		31	11.2	70

Note: 1. For use with braided hoses.

2. If use with spiral hose, hose fitting series number is 156 2-x x-x x

NOTES

The drawings in this catalogue are for reference only, and their dimensions and proportions may be a little different from those of the real products.

Products included in this catalogue don't refer to all, so if customers are interested in other products, please don't hesitate to contact our company for further information.

Our company has made much effort to record the correct data in this publication. However, in order to promote our products, we may make some changes of their size or description, which haven't been shown yet. We reserve the rights for explanation, but sorry for no further notice to customer the change of products' design, description or even stop of some products' manufacture in future.